

# New 2026



**RIZZOLI**<sup>®</sup>

FIRE SINCE 1912







4

New R Series

16

New STP Series

20

New X Series

32

Horizontal inserts

40

Vertical inserts

44

ZVI Series

48

ML Series

52

S Series

58

L Series

# NEW R SERIES





# NEW R SERIES. TECHNICAL AND AESTHETIC EVOLUTION.

Discover a new standard of excellence, where craftsmanship, style and aesthetics come together in perfect harmony.

## ESSENZA

- Painted steel finish
- Black doors and handles
- Fire door with triple glazing as standard
- Wood box with integrated handle



Doors options  
(optional)



Stainless steel doors  
and handles

Glass doors  
and black handles



## INOX

- Stainless steel finish
- Stainless steel doors and handles
- Fire door with triple glazing as standard
- Wood box with handle



Fire door option  
(optional)



Solid stainless steel  
fire door



## AVANT

- Painted steel finish
- Stainless steel doors and handles
- Fire door with triple glazing as standard
- Wood box with handle



Fire door option  
(optional)

Solid fire door  
in Avant finish



## EPOKA

- Painted steel finish
- Stainless steel doors, knobs and handles
- Fire door with triple glazing as standard
- Wood box with knob



Fire door option  
(optional)

Solid fire door  
in Epoka finish



# Excellence, in every detail

Designed to meet the most sophisticated market demands, the new R Series represents a vision of uncompromising excellence. Its top-tier features, included as standard, establish an entirely new benchmark in quality. This is where Rizzoli's century-long expertise converges with innovation, shaping a design philosophy rooted in craftsmanship, ongoing research, and absolute precision. Every detail has been carefully engineered to simplify installation within cabinetry, achieving the highest level of integration. This advanced design flexibility completes an exclusive offering, seamlessly adapting to any project.

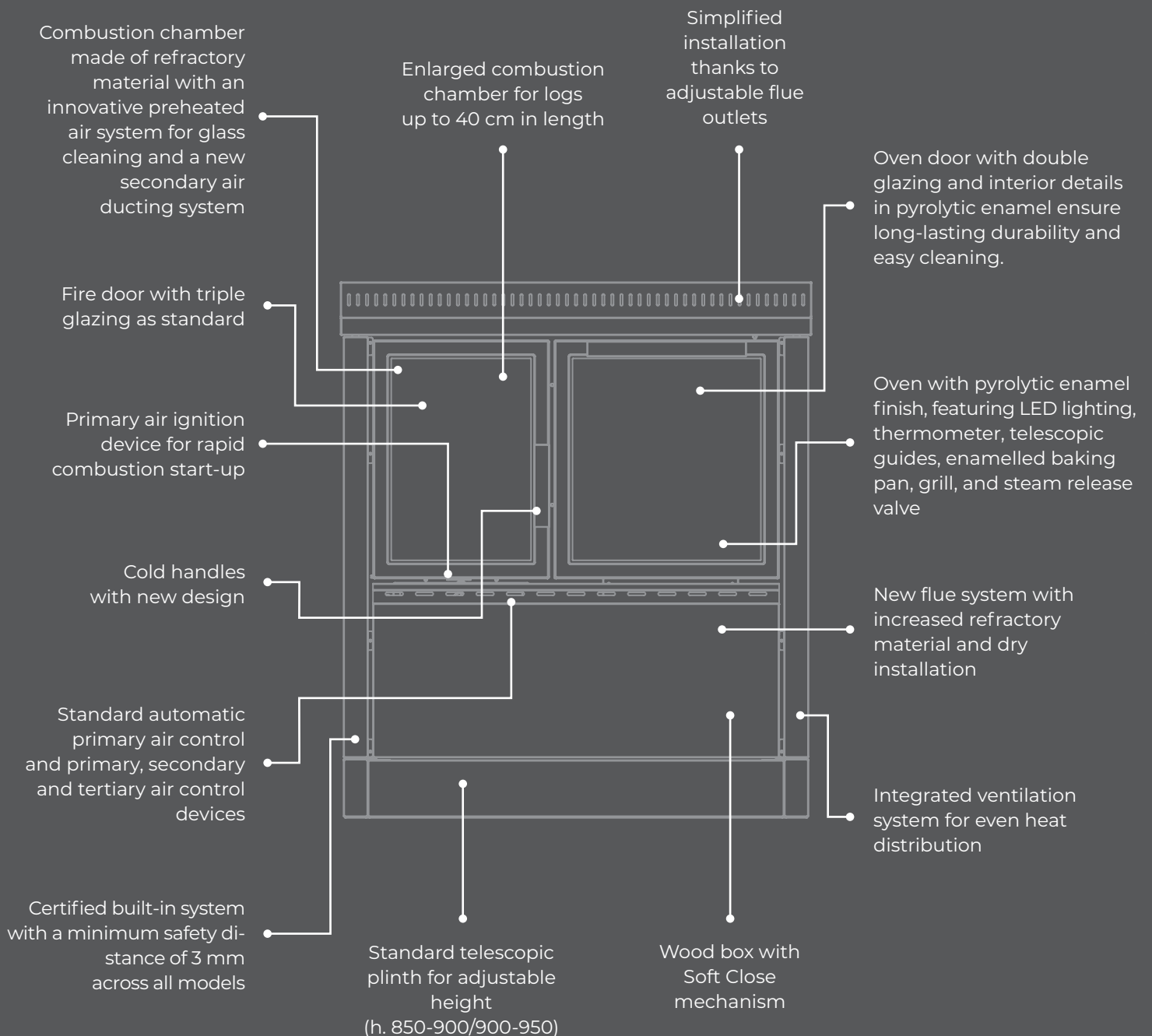

# New R Series

WOOD - BURNING COOKERS

## The range that suits your space

The New R Series is based on the idea of simplification: a clear and straightforward range, in which each model is identified by the letter R. Models without an oven or with a side-mounted oven, available in various sizes and finishes (Essenza, Stainless steel, Avant, Epoka) to offer maximum freedom of choice. All models come as standard with a triple-glazed fire door and are ready for built-in installation between units, without the need for additional side insulation.



## WITHOUT OVEN

### Available models and dimensions (WxDxH)

R 40	400x600x850-900/900-950 mm
R 50	500x600x850-900/900-950 mm
R 60 SF	600x600x850-900/900-950mm



## WITH OVEN

### Available models and dimensions (WxDxH)

R 60	600x600x850-900/900-950 mm
R 70	700x600x850-900/900-950 mm
R 80	800x600x850-900/900-950 mm
R 90	900x600x850-900/900-950 mm
R 100	1000x600x850-900/900-950 mm

### Oven dimensions (WxDxH)

R 60	250x430x260 mm
R 70	250x430x260 mm
R 80	300x430x260 mm
R 90	350x430x260 mm
R 100	450x430x260 mm



Technologies:



# New R Series: Essenza

## A minimalist, contemporary aesthetic

The Essenza finish embodies a contemporary aesthetic, thanks to the painted steel sides and wood box. It comes as standard with a triple-glazed fire door and a recessed wood box opening, creating a clean, seamless design. The standard configuration features black doors and handles. On request, Essenza can be customised with stainless steel doors and handles, or with frameless glass doors, which enhance the purity of the lines and the continuity of the surfaces. The Essenza finish does not include a solid fire door.

## BASIC CONFIGURATION ESSENZA FINISH

### CHARACTERISTICS

- Black painted fire and oven doors
- Fire door with triple glazing
- Black handles
- Wood box with integrated handle
- Sides in painted steel



### AVAILABLE COLORS

- Black
- White
- Bordeaux Red
- Anthracite
- Sand
- Bronze
- Silver
- Pearl
- RAL (optional)

## FIRE DOORS OPTIONS (optional)



### CHARACTERISTICS

- Stainless steel fire and oven doors
- Stainless steel handles



### CHARACTERISTICS

- Fully glazed fire and oven doors
- Black handles

The fire and oven doors are made entirely of glass, with no frames, for a clean, contemporary look.



# New R Series: Avant

## The harmony of steel and colour

The depth of the coloured surfaces meets the symmetrical stainless steel frames, creating a visual balance that evokes the solidity of tradition reinterpreted in a contemporary key. The Avant finish is an evolution of the Variant finish, and the basic configuration features stainless steel doors and handles on the wood-burning unit, fire and oven door. On request, Avant can be configured with a solid fire door in the same finish and colour as the wood-burning unit, a choice that accentuates the classic style.

## BASIC CONFIGURATION AVANT FINISH

### CHARACTERISTICS

- Stainless steel fire and oven doors
- Fire door with triple glazing
- Stainless steel handles
- Wood box with handle
- Sides in painted steel



### AVAILABLE COLORS

- Black
- White
- Bordeaux Red
- Anthracite
- Sand
- Bronze
- Silver
- Pearl
- RAL (optional)

## FIRE DOOR OPTION (optional)



### CHARACTERISTICS

- Solid fire door in Avant finish



# New R Series: Epoka

## The timeless elegance of tradition

The charm of tradition takes shape in the design through refined decorative details, steel inserts, and ornamental knobs, enhancing the wood-burning cooker with a sense of classic elegance. Three different decorative versions (P46, P56, P59) are available as standard, each designed to add a unique and personalized touch. The base configuration features stainless steel doors, a fire door with handle, and decorative knobs on the oven door and wood box to further emphasize its distinctive character. Upon request, Epoka can be configured with a solid fire door in a matching finish and colour, perfectly coordinated with the cooker.

## BASIC CONFIGURATION EPOKA FINISH

### CHARACTERISTICS

- Stainless steel fire and oven doors
- Fire door with triple glazing
- Fire door with stainless steel handle
- Wood box with stainless steel knob
- Oven door opening with stainless steel knob
- Sides in painted steel



### AVAILABLE COLORS

- Black
- White
- Bordeaux Red
- Anthracite
- Sand
- Bronze
- Silver
- Pearl
- RAL (optional)

## FIRE DOOR OPTION (optional)



### CHARACTERISTICS

- Solid fire door in Epoka finish



RIZZOLI

# NEW STP SERIES





# The evolution of quality.

The STP Series has always represented the pinnacle of Rizzoli wood-burning thermo-cookers, setting the standard in the market for performance, reliability and ease of use.

With an output of up to 30.7 kW, a spacious combustion chamber with a variable wood-loading system and a design intended for intuitive installation, the STP is engineered to deliver warmth, efficiency and everyday comfort. The ability to manage the water for heating and the domestic hot water circuit separately confirms its advanced and comprehensive design. Today, the STP Series evolves: discover how tradition meets a new technical and aesthetic expression.

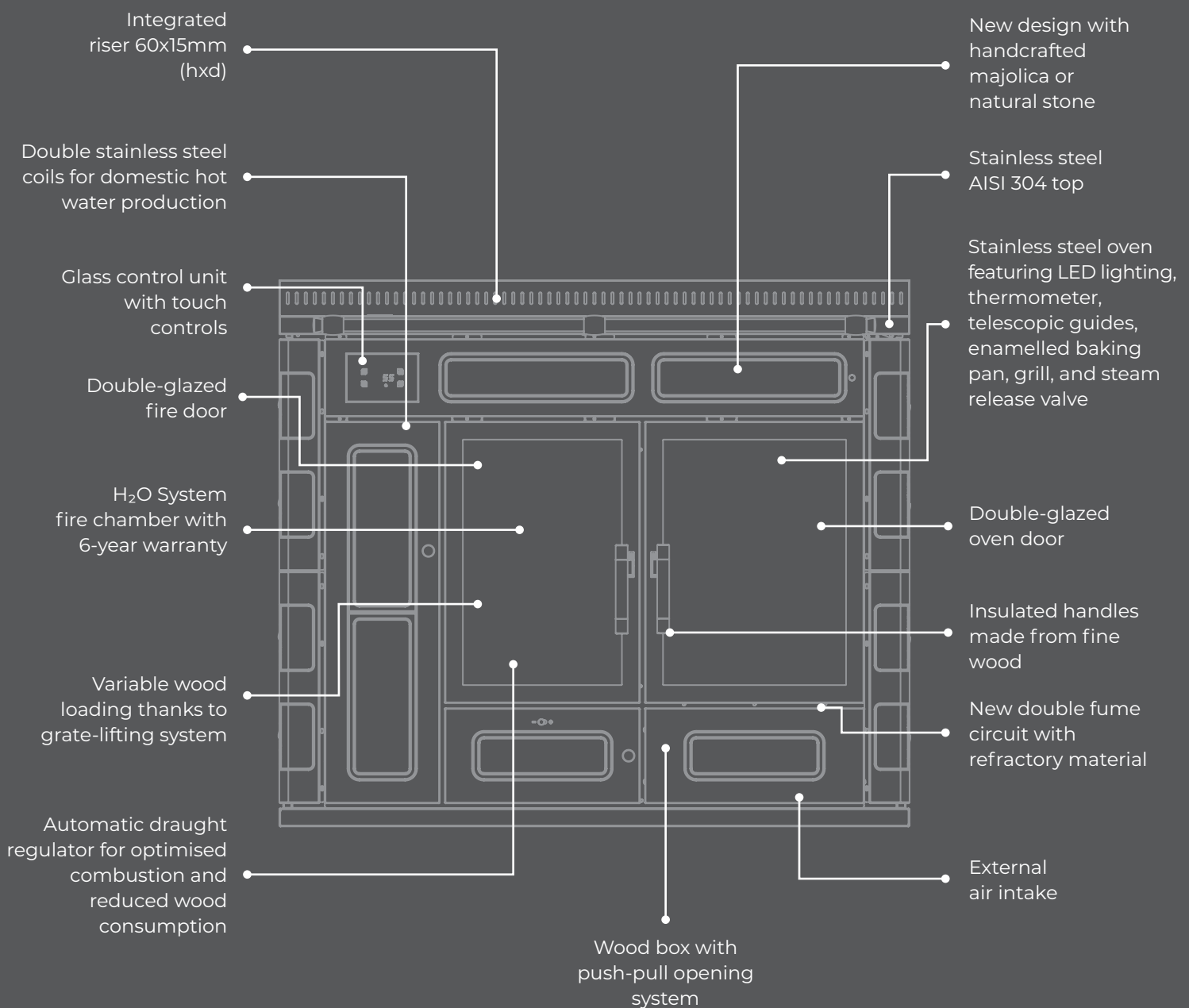

# New STP Series

WOOD - BURNING THERMO - COOKERS

The new STP Series is enriched with a new look that harmonises beautifully with traditional tastes. Introducing STP Rustica, a finish that enhances the wood-burning thermo-cooker with hand-crafted majolica tiles or natural stone, transforming it into a piece of great aesthetic and historical value.



## STP Rustica

### Dimensions (WxDxH)

1050x600x850 mm



### Oven dimensions (WxDxH)

350x430x279 mm



370 11,2-30,7

### Available colors:

- Majolica White 
- Majolica Red 



## STP Rustica

### Dimensions (WxDxH)

1050x600x850 mm

### Oven dimensions (WxDxH)

350x430x279 mm



385 11,2-30,7

### Available colors:

- Natural stone 



### Technologies:



# NEW X SERIES





# A new expression of warmth

A range of state-of-the-art wood-burning stoves that embodies and reflects Rizzoli's century-long expertise in wood-fired heating. Versatile and modern, it is the result of combining solid, high-quality materials with a concept of eco-friendly heating. Today, the New X Series is enhanced with new standard features, alongside new finishes in stoneware, majolica and stone, to make every stove even more complete, advanced and unique in its kind.

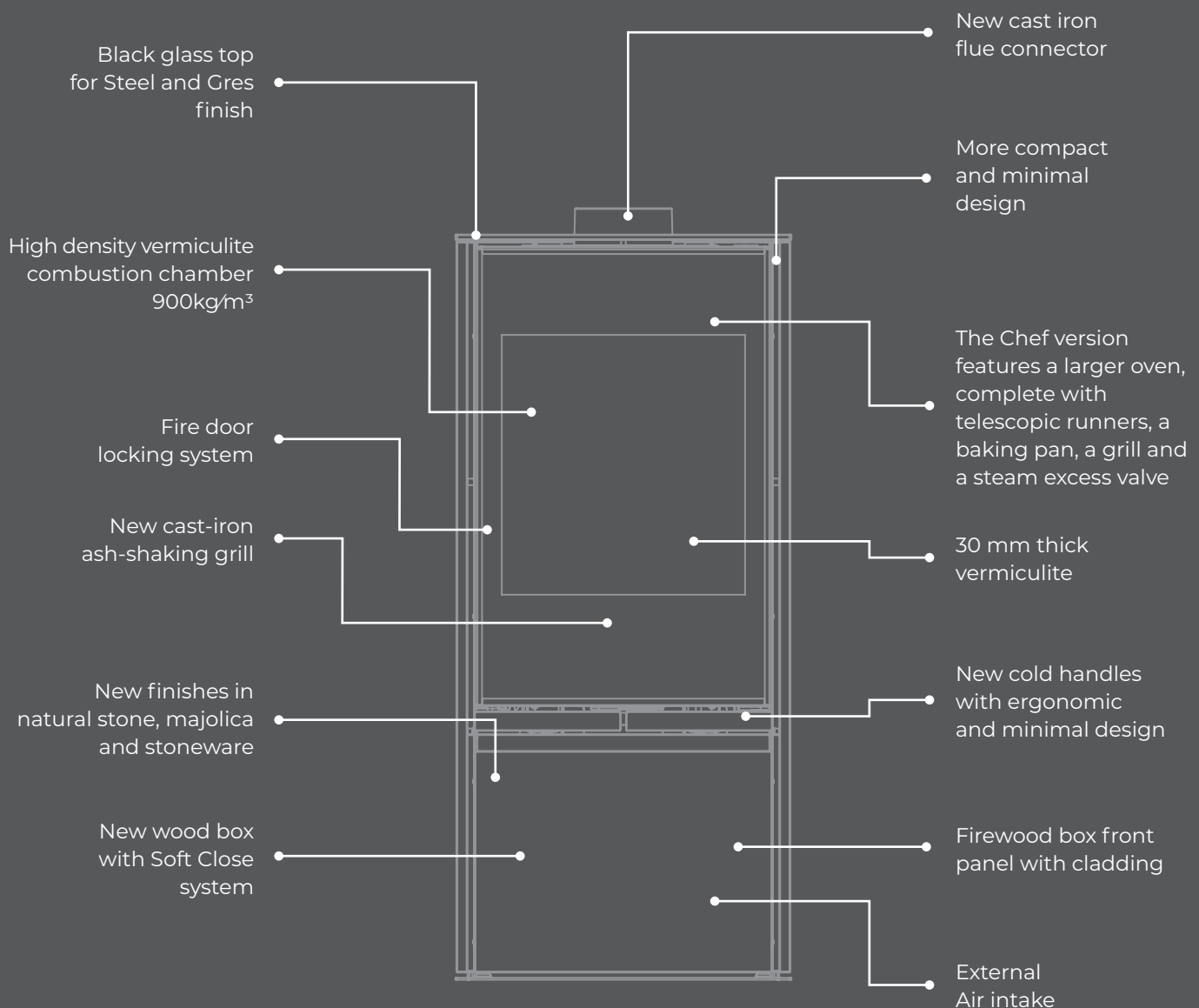

# New X Series

WOOD-BURNING STOVES



## X Steel

### Dimensions (WxDxH)

511x480x1133 mm



### Available colors:

- Black painted steel ●



## X Stone

### Dimensions (WxDxH)

559x480x1162 mm



### Available colors:

- Natural stone ●



### Technologies:



# New X Series

WOOD - BURNING STOVES



## X Majolica



### Dimensions (WxDxH)

559x480x1162 mm



255 7,4 12,0

### Available colors:

- Matte white 
- Bordeaux Red 
- Matt Dove Grey 



## X Gres



### Dimensions (WxDxH)

511x480x1133 mm



190 7,4 12,0

### Available colors:

- Graphite 
- Ash 
- Sand 



### Technologies:





The warmth that accompanies time.

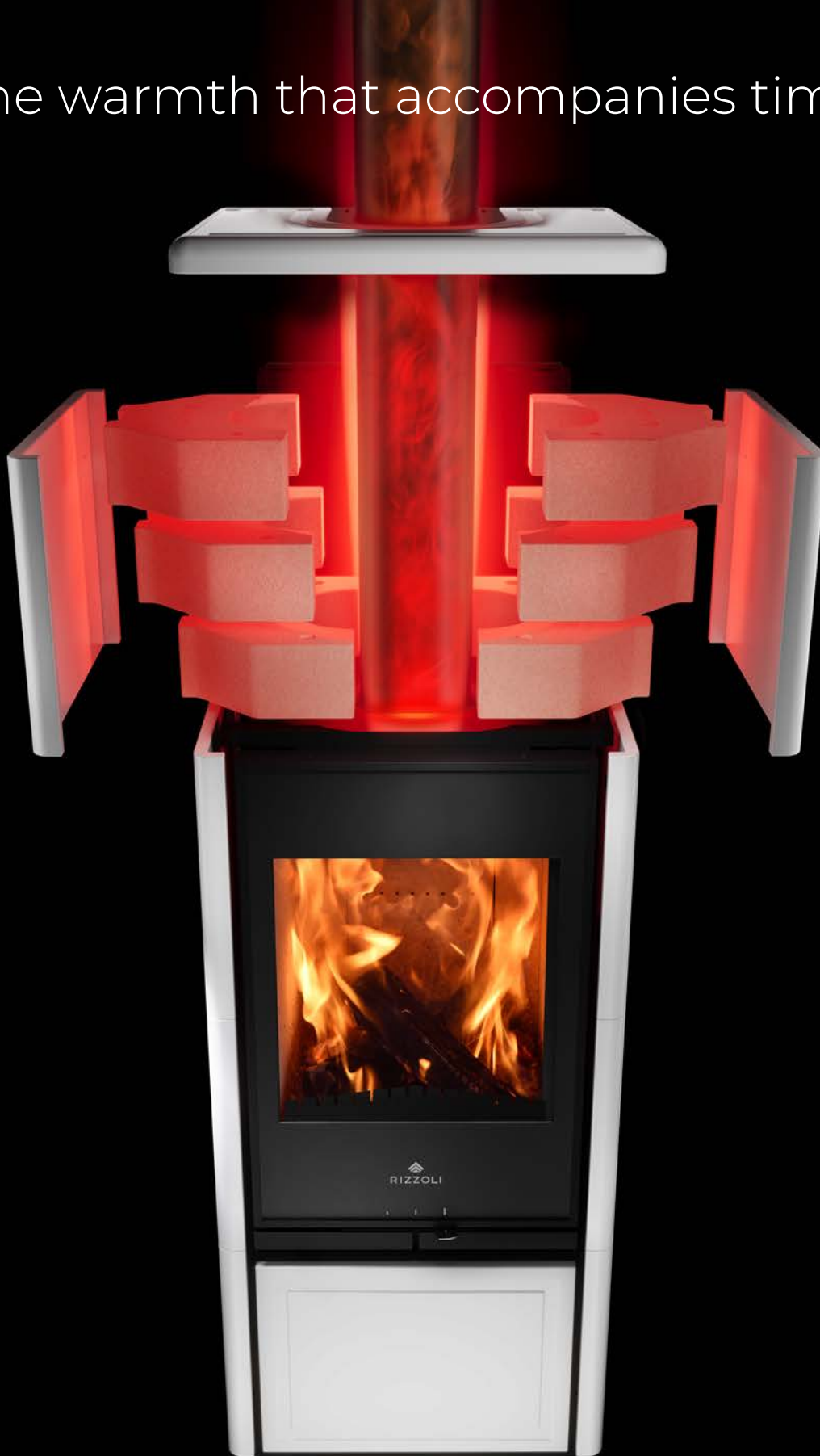

The experience gained in the field of storage stoves, combined with extensive testing carried out in the laboratories of Rizzoli's Research and Development department, has led to the development of **HeatForm®**, the new thermal storage blocks made from innovative refractory compounds. An advanced solution that improves the stove's overall performance, increases heat storage capacity and significantly prolongs heat release, for a more natural and lasting comfort.

# New X Plus Series

WOOD-BURNING STORAGE STOVES



## X Steel Plus

### Dimensions (WxDxH)

511x480x1506 mm

 **KG**  **kW**  **kW MAX**  
194/264\* 7,4 12,0

### Available colors:

- Black painted steel 





\* Weight without and with (70 kg) heat accumulation kit (optional).



## X Stone Plus

### Dimensions (WxDxH)

559x480x1535 mm

 **KG**  **kW**  **kW MAX**  
317/387\* 7,4 12,0

### Available colors:

- Natural stone 



\* Weight without and with (70 kg) heat accumulation kit (optional).

Technologies:



# New X Plus Series



WOOD - BURNING STORAGE STOVES





## X Majolica Plus

### Dimensions (WxDxH)

559x480x1535 mm

 288/358\*  7,4  12,0

### Available colors:

- Matte white 
- Bordeaux Red 
- Matt Dove Grey 



\* Weight without and with (70 kg) heat accumulation kit (optional).

Technologies:





# New X Chef Series

WOOD-BURNING STOVES WITH OVEN



## X Steel Chef

### Dimensions (WxDxH)

511x480x1506 mm

### Oven dimensions (WxDxH)

350x410x216 mm

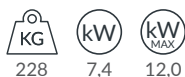

### Available colors:

- Black painted steel 



## X Stone Chef

### Dimensions (WxDxH)

559x480x1535 mm

### Oven dimensions (WxDxH)

350x410x216 mm

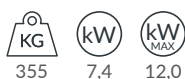

### Available colors:

- Natural stone 



Technologies:



## X Majolica Chef

### Dimensions (WxDxH)

559x480x1535 mm

### Oven dimensions (WxDxH)

350x410x216 mm



295



7,4



12,0

### Available colors:

- Matte white
- Bordeaux Red
- Matt Dove Grey



# HORIZONTAL WOOD-BURNING INSERTS





# Components, materials and technologies for an unmatched product

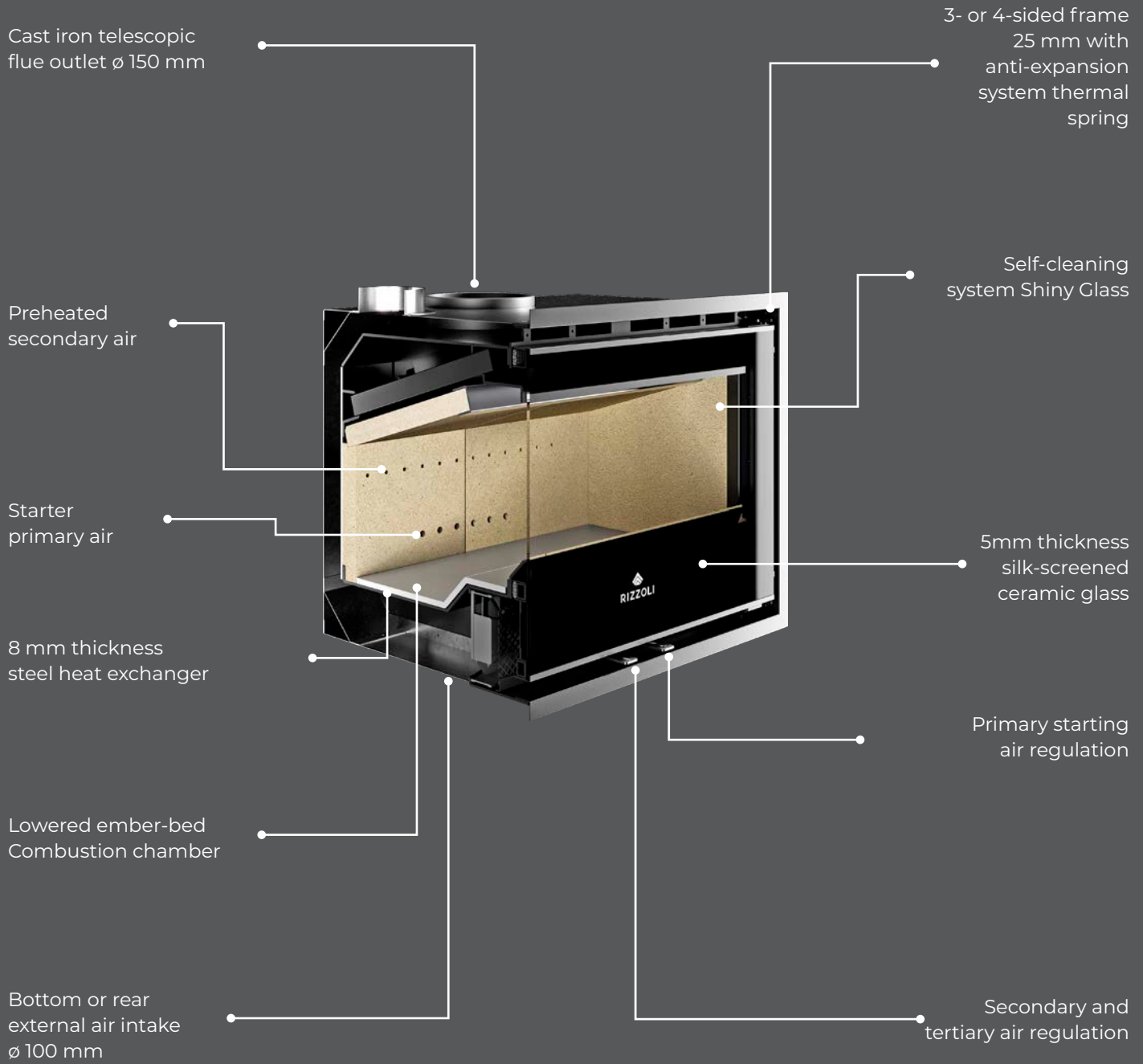

Independent ducting  
ø 120 mm (optional)

4 mm thickness steel  
combustion chamber

30 mm vermiculite  
high density  
(900 kg/m<sup>3</sup>)  
combustion chamber

Ash stopper  
deflector

Axial ventilation kit with  
dual independent turbines  
Hot Air Flow® (optional)



Switch for thermostated  
or manual multi-speed  
ventilation

Independent front  
ventilation (optional)

Door gasket

Reversible  
steel fire  
door

Handle with  
retractable opening  
and always cold  
with Soft Touch  
effect

Micro switch for  
ventilation stop when  
the door is open

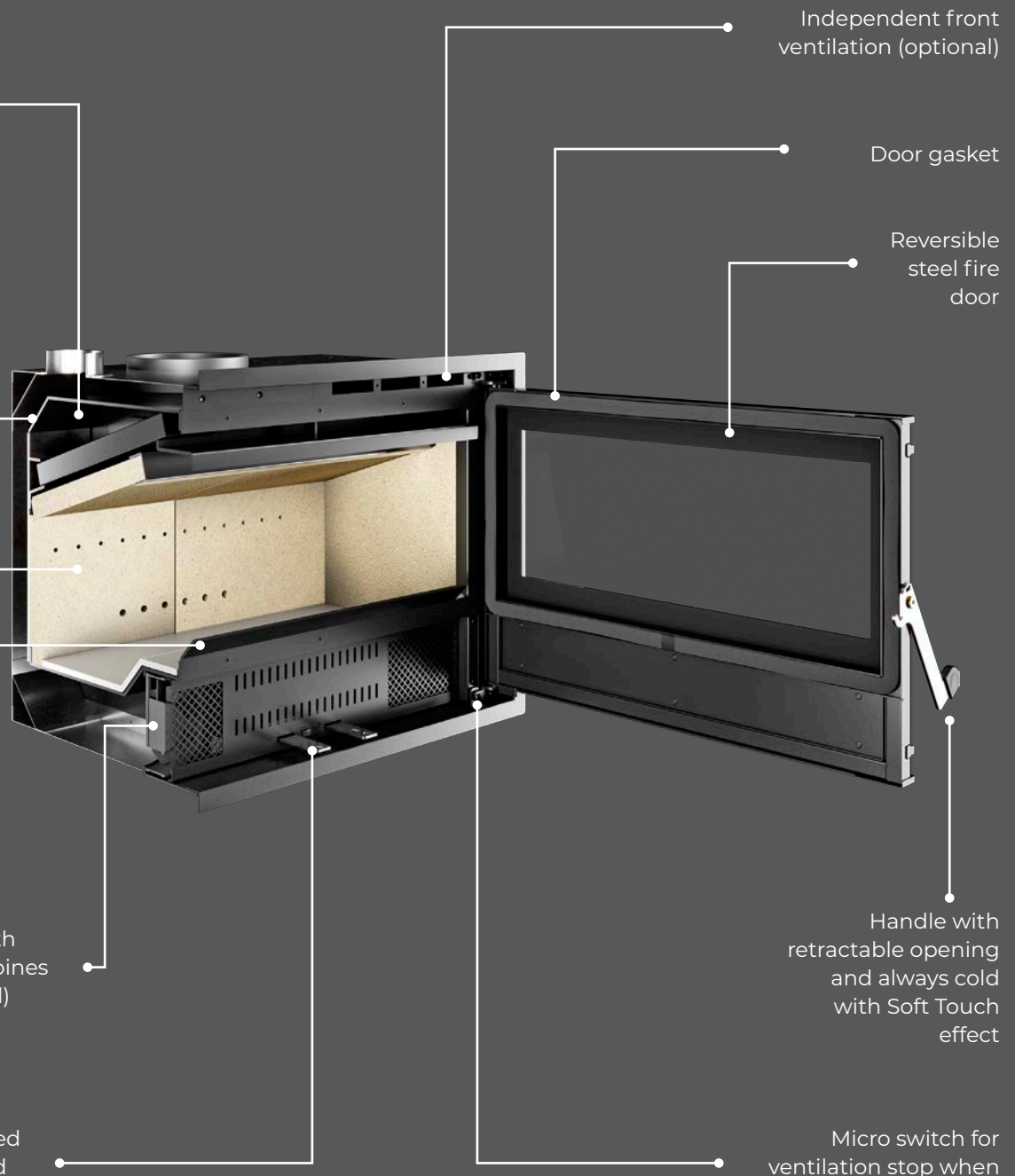

# X Series

HORIZONTAL WOOD-BURNING INSERTS



## X 70 L

### Dimensions (WxDxH)

680x420x480 mm



- Frame standard choice: 4 sides 25 mm  
3 sides 25 mm
- Custom frame: optional
- Ventilation and ducting kit: optional



## X 80 L

### Dimensions (WxDxH)

780x420x480 mm



- Frame standard choice: 4 sides 25 mm  
3 sides 25 mm
- Custom frame: optional
- Ventilation and ducting kit: optional



Technologies:





# X Series

HORIZONTAL WOOD-BURNING INSERTS



## X 70 XL

### Dimensions (WxDxH)

680x420x540 mm



- Frame standard choice: 4 sides 25 mm  
3 sides 25 mm
- Custom frame: optional
- Ventilation and ducting kit: optional



## X 80 XL

### Dimensions (WxDxH)

780x420x540 mm



- Frame standard choice: 4 sides 25 mm  
3 sides 25 mm
- Custom frame: optional
- Ventilation and ducting kit: optional



Technologies:





# VERTICAL WOOD-BURNING INSERTS





# X Series

VERTICAL WOOD-BURNING INSERTS



## X 50 V

### Dimensions (WxDxH)

520x450x827 mm



- Frame standard 4 sides 25 mm  
choice: 3 sides 25 mm



Technologies:





# ZVI SERIES





# ZVI Series

WOOD-BURNING COOKERS







## ZVI 60

### Dimensions (WxDxH)

600x600x850-910 mm



### Available colors:

- Black 
- White 
- Bordeaux Red 
- Anthracite 
- Stainless steel 







## ZVI 80

### Dimensions (WxDxH)

800x600x850-910 mm



### Available colors:

- Black 
- White 
- Bordeaux Red 
- Anthracite 
- Stainless steel 



### Technologies:





- New combustion chamber with a 20% increase in volume
- Safe Secure installation between cabinet units with lateral safety distance of 3 mm
- New Shiny Glass system for optimal glass cleaning
- Adjustable height (850–910 mm)
- ZVI 60 multi-flue above and at the rear on the right
- ZVI 80 multi-flue above in the centre and at the rear on the right
- ZVI 60, ZVI 80 pre-fitted for flue outlet on the right-hand side (optional kit)

# M SERIES





# Heat takes shape in fire.

The new ML-MZ Series elevates wood-fired cooking with premium features and a distinctive design that places the flame at the heart of the experience. The fire becomes the true focal point, while the spacious oven delivers consistent heat distribution and generous capacity to meet every cooking need. Newly reduced safety distances—now certified at just 3 mm on the sides—enable safe installation between units, offering greater flexibility in design and layout.

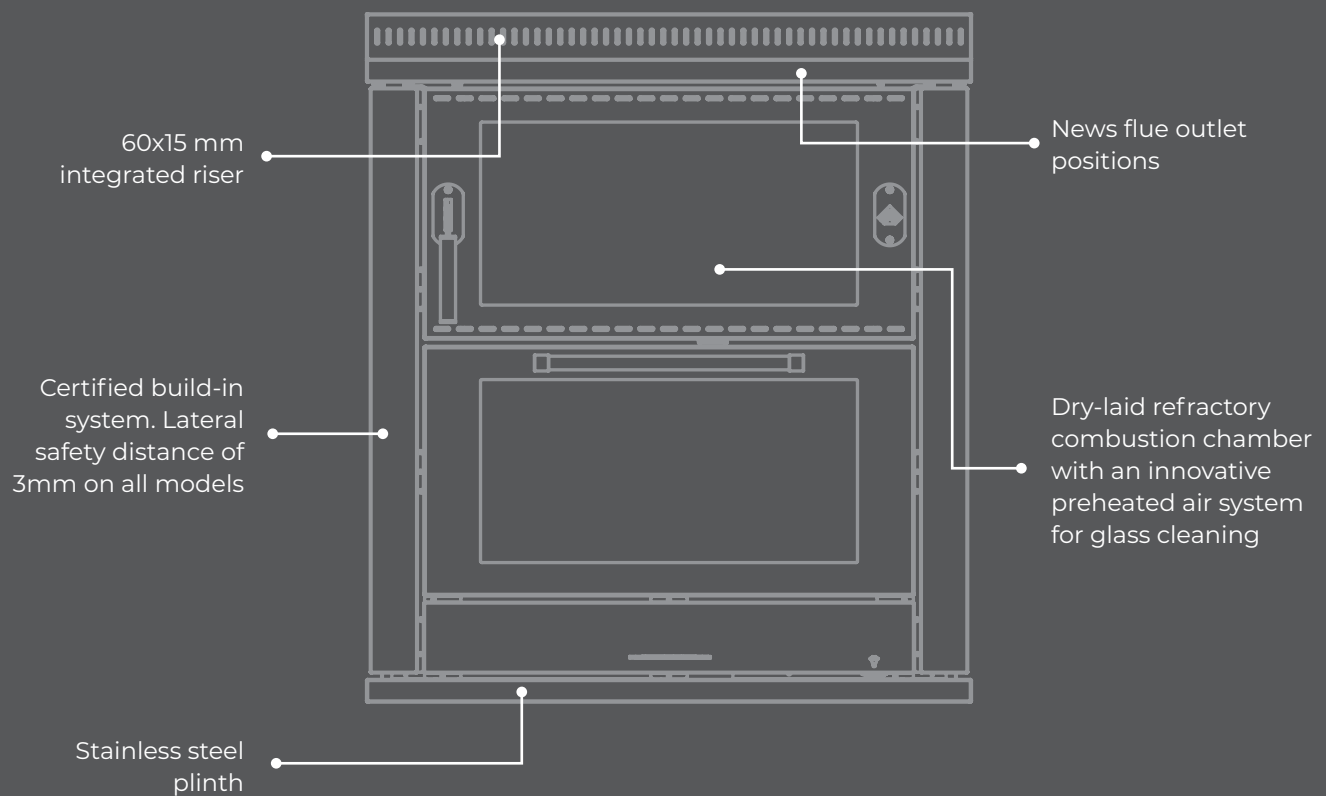

# ML Series

WOOD-BURNING COOKERS

The ML Series now features new stoneware finishes, designed to highlight the textural character of the wood-burning cooker through solid, durable and refined surfaces.





## ML 60 Gres

### Dimensions (WxDxH)

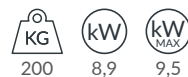
600x600x850 mm



### Available colors:

- Graphite 
- Ash 
- Sand 





## ML 80 Gres

### Dimensions (WxDxH)

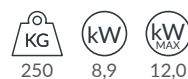
800x600x850 mm



### Available colors:

- Graphite 
- Ash 
- Sand 



### Technologies:



# S SERIES





# New S Series: the evolution of fire

In the New S Series, the combustion chamber has been completely redesigned, with a 20% increase in volume, a thick refractory lining and a depth of 410 mm, designed to accommodate longer logs and ensure greater burn time. The new Shiny Glass® system keeps the glass clean for longer thanks to preheated air flows, while the Air Control® automatic primary air management and secondary air adjustment ensure optimal combustion at every stage. Moreover, the certified side safety distance of just 3 mm offers unprecedented installation freedom, without compromising on the features and performance that have made the S Series a benchmark in its segment.

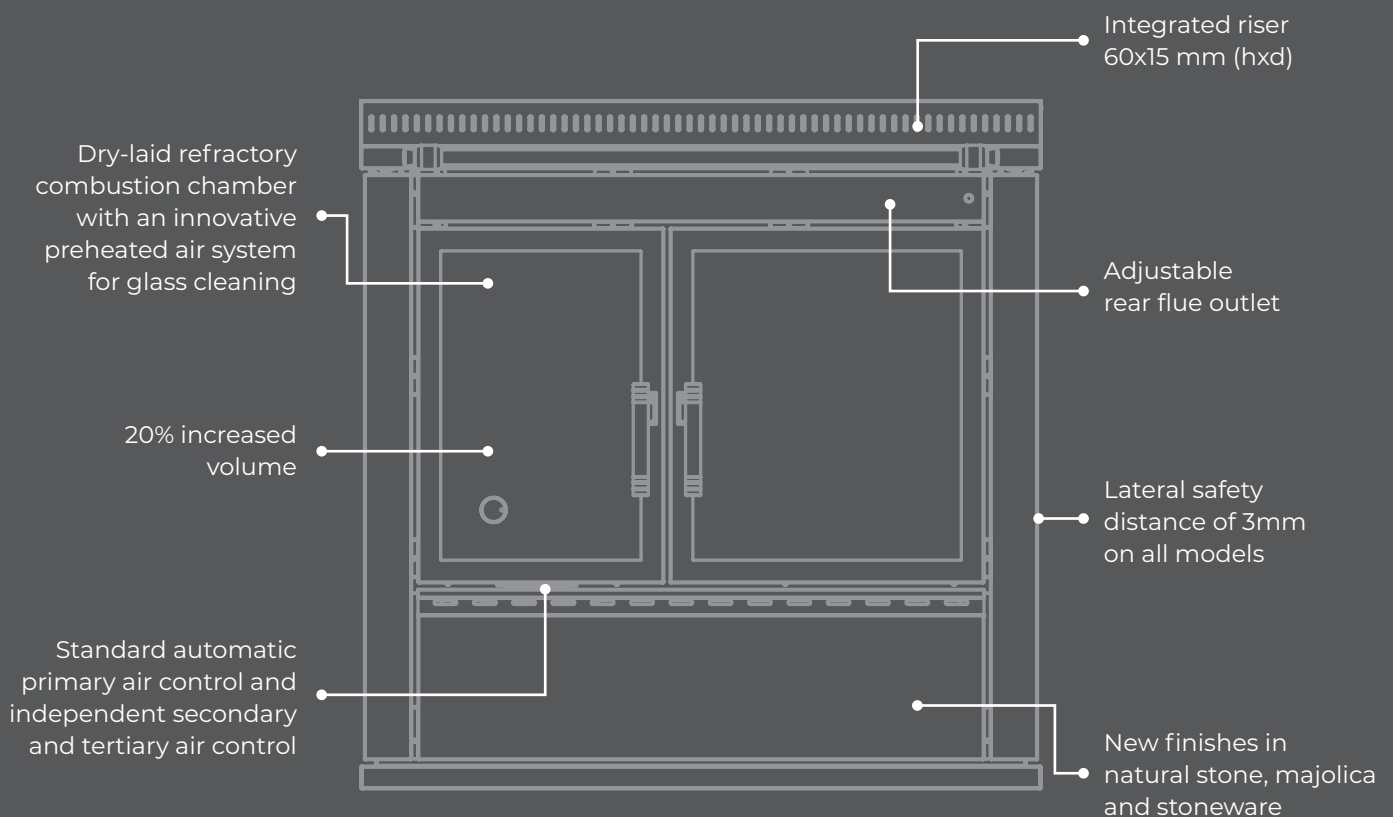

# S Series

WOOD - BURNING COOKERS

The S Series now features new stoneware finishes, designed to highlight the textural character of the wood-burning cooker through solid, durable and refined surfaces.





## S 60 Gres

### Dimensions (WxDxH)

600x600x850 mm



### Available colors:

- Graphite 
- Ash 
- Sand 



## S 80 Gres | S 90 Gres



### Dimensions (WxDxH)

S 80 800x600x850 mm

S 90 900x600x850 mm



### Available colors:

- Graphite 
- Ash 
- Sand 



### Technologies:



# S Series

## WOOD-BURNING COOKERS

The Rustik S Series features beautiful hand-crafted majolica tiles or fine natural stone panels adorning the sides of the wood-burning cooker. These cladding materials ensure significant heat accumulation during combustion and a constant, gradual release of heat in the hours that follow, even after the fire has gone out.



### S 60 Rustik

#### Dimensions (WxDxH)

600x600x850 mm

    
219/231 7,3 8,5

#### Available colors:

- Majolica White
- Majolica Red
- Natural stone





### S 80 Rustik | S 90 Rustik

#### Dimensions (WxDxH)

**S 80 Rustik** 800x600x850 mm

**S 90 Rustik** 900x600x850 mm

    
229/241-264/276 8,5 12,0/12,5

#### Available colors:

- Majolica White
- Majolica Red
- Natural stone



#### Technologies:



A design intended for use both in the kitchen and the living room, with a look that suits any setting thanks to its wide range of finishes.



# L SERIES





# L Series

WOOD-BURNING COOKERS



## L 90 Rustik

### Dimensions (WxDxH)

900x600x850 mm

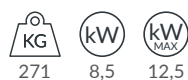

### Available colors:

- Majolica White
- Majolica Red



## L 90 Rustik

### Dimensions (WxDxH)

900x600x850 mm

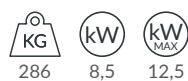

### Available colors:

- Natural stone



### Technologies:



- New combustion chamber with dry-laid refractory bricks with a 20% increase in volume
- New Shiny Glass system for optimal glass cleaning
- Air Control® automatic primary air adjustment
- Adjustable rear flue outlet
- Screen-printed ceramic glass
- Stainless steel plinth



# The authentic wood-fired pizza!



We're pleased to introduce our new refractory pizza stone, an exclusive accessory designed to fit perfectly inside our range of wood-burning cookers with oven.

Crafted from premium-quality refractory material, this stone is engineered to absorb and evenly release heat throughout the oven. The result is consistently excellent performance, allowing you to achieve professional-level pizzas with a perfectly crisp base and uniform cooking.

## CHARACTERISTICS

- High heat-retention firebrick
- Even heat distribution
- Ideal for bread, focaccia, and other leavened products
- Easy to place inside the oven



Rizzoli continuously strives to improve its products. For this reason, the technical and styling characteristics in this catalogue may undergo changes without notice.

# Discover the new website Rizzoli Professional



[www.rizzoli-professional.it](http://www.rizzoli-professional.it)



**Rizzoli** srl / Single seat  
 Zona Artigianale, 1 / Frazione San Lugano  
 39040 Trodena nel Parco Naturale (BZ) Italy  
 ph +39 0471 887551 / [info@rizzolicucine.it](mailto:info@rizzolicucine.it) / [www.rizzolicucine.it](http://www.rizzolicucine.it)

