

S T U F E   A   L E G N A

# SERIE X



**RIZZOLI**<sup>®</sup>

FIRE SINCE 1912

# Un secolo di storia. La nostra.

Quando nel 1912 il fondatore Carlo Rizzoli iniziò a lavorare come fabbro magnano alle pendici delle Dolomiti, nessuno avrebbe mai immaginato a cosa quelle abili mani avrebbero portato.

Oggi, a distanza di oltre un secolo, Rizzoli produce e commercializza prodotti in tutta Europa e nel mondo. Nel tempo Rizzoli ha aggiunto alla abilità artigiana l'impiego delle migliori tecnologie e dei migliori materiali.

Questa è in sintesi la nostra storia.









# Immersi in un parco naturale

L'headquarter dell'azienda da 25.000 m2 si trova a oltre 1000 metri sul livello del mare e all'interno del Parco Naturale Monte Corno, un'area protetta di oltre 6000 ettari incastonata nello splendido scenario delle Dolomiti alto atesine. A pochi chilometri di distanza dalla sede si trovano gruppi montuosi di straordinaria bellezza quali Latemar, Catinaccio, Sciliar e il geoparco Bletterbach, tutti inseriti nell'elenco dell'Unesco, patrimonio dell'umanità.







Rizzoli



# Materie prime

Quando progettiamo un prodotto, pensiamo a chi lo userà. Per questo selezioniamo con cura le materie prime, ottimizziamo i processi, testiamo le funzionalità e studiamo l'estetica. Se tutto ci soddisfa, facciamo ancora qualcosa in più.



# Esperienza

Il tempo ci ha permesso di maturare l'esperienza che oggi, unita all'utilizzo delle più moderne tecnologie, ci rende un marchio conosciuto per l'alta qualità e l'affidabilità dei nostri prodotti, fatti come una volta ma perfetti per il presente.





# Artigianalità

In Rizzoli non esiste la catena di montaggio, ma ogni addetto assembla completamente il prodotto dall'inizio alla fine, per garantire i più elevati standard qualitativi.







serigrafia

|    |    |    |    |    |    |    |    |    |     |
|----|----|----|----|----|----|----|----|----|-----|
| 1  | 2  | 3  | 4  | 5  | 6  | 7  | 8  | 9  | 10  |
| 11 | 12 | 13 | 14 | 15 | 16 | 17 | 18 | 19 | 20  |
| 21 | 22 | 23 | 24 | 25 | 26 | 27 | 28 | 29 | 30  |
| 31 | 32 | 33 | 34 | 35 | 36 | 37 | 38 | 39 | 40  |
| 41 | 42 | 43 | 44 | 45 | 46 | 47 | 48 | 49 | 50  |
| 51 | 52 | 53 | 54 | 55 | 56 | 57 | 58 | 59 | 60  |
| 61 | 62 | 63 | 64 | 65 | 66 | 67 | 68 | 69 | 70  |
| 71 | 72 | 73 | 74 | 75 | 76 | 77 | 78 | 79 | 80  |
| 81 | 82 | 83 | 84 | 85 | 86 | 87 | 88 | 89 | 90  |
| 91 | 92 | 93 | 94 | 95 | 96 | 97 | 98 | 99 | 100 |

# Tecnologia

Per noi l'innovazione non è un obiettivo da raggiungere: è un metodo di lavoro. Ogni anno investiamo buona parte delle nostre risorse in Ricerca & Sviluppo perché sappiamo che migliorare è l'unico modo per continuare a offrire un prodotto di riconosciuta qualità.









# Serie X. Qualità a 5 stelle.

Quando abbiamo progettato questa stufa a legna volevamo un prodotto capace di stupire al primo sguardo, dove il fuoco tornasse ad essere il protagonista assoluto e dove il calore sprigionato potesse durare più a lungo possibile. Una stufa versatile, moderna, costruita con materiali solidi e di pregio, una stufa concepita per riscaldare in modo sano ed ecologico. Una stufa unica e irripetibile. E' nata così la Serie X, una linea di stufe a legna di ultima generazione che racchiude tutta la centenaria esperienza Rizzoli nel campo del riscaldamento a legna.

# Qualità senza compromessi





# CARATTERISTICHE PRINCIPALI

## Autonomia



La camera di combustione permette grandi carichi di legna con potenza fino a 13 kw e un consumo di 2 kg/h.

## Design



Il design della Serie X si caratterizza di linee moderne ed essenziali che ne esaltano lo stile.

## Vermiculite

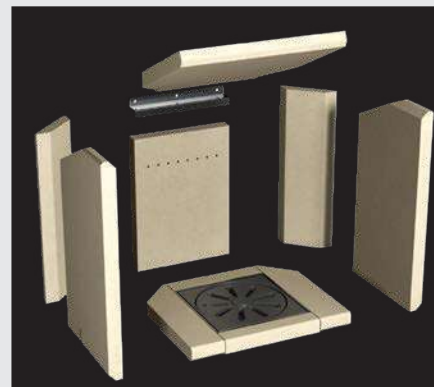

La camera di combustione è composta da vermiculite ad alta densità (850 kg/m<sup>3</sup>).

## Sicurezza



La porta fuoco ha una chiusura automatica di sicurezza comandata da una maniglia ergonomica isolata.

## Visione del fuoco



Il vetro ceramico con sistema autopulente regala una visione sul fuoco sempre unica e perfetta.

## Corpo ermetico



Il cuore della Serie X è composto da una camera di combustione ermetica ed altamente efficiente.

## Presenza aria



La presa d'aria External Air®, permette l'utilizzo di aria proveniente dall'esterno ideale per case passive.

## Controllo aria



Un'unica leva di controllo per gestire in modo facile e preciso la combustione.

## Facile pulizia



La graticola cenere rotante e il cassetto raccogli cenere, facilitano la pulizia ordinaria della stufa.



# Serie X Basic



## Una vista sul fuoco davvero unica

La Serie X Basic è la stufa a legna in versione base con ampia camera di combustione e vano porta legna. La stufa, dalle linee moderne ed essenziali, è costruita con materie prime di altissimo livello, moderne tecnologie e cura artigianale dei dettagli.





# Serie X Basic



STUFE A LEGNA



## X Line Basic



Misure (LxPxH)  
534x464x1145 mm

    
175 9,5 13,0



- Acciaio verniciato Nero
- Sportello inferiore (optional)



## X Rock Basic



Misure (LxPxH)  
554x462x1163 mm

    
275 9,5 13,0

- Pietra Naturale



# Serie X Basic

STUFE A LEGNA



## X Art Basic



Misure (LxPxH)  
600x476x1173 mm

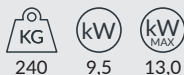

240 9,5 13,0

- Maiolica
- Sportello inferiore (optional)

Valori contributo Conto termico 2.0.  
Riscaldamento a legna. Fonte di grande risparmio.

| Modello | kW     | A        | B        | C        | D         | E         | F         |
|---------|--------|----------|----------|----------|-----------|-----------|-----------|
| X BASIC | 9,5 kW | 543,01 € | 769,27 € | 995,52 € | 1267,03 € | 1538,53 € | 1629,03 € |

Finiture: pag. 38  
Area tecnica: pag. 44

Tecnologie:



# Serie X Plus

## La scorta di calore che desideravi

Grazie alla grande quantità di materiale refrattario aggiuntivo (kit optional da 70 kg), la versione Plus della Serie X garantisce molte ore di piacevole calore anche dopo lo spegnimento della fiamma. Il sistema prevede l'installazione di tre speciali anelli accumulatori installati immediatamente sopra la camera di combustione della stufa a legna e realizzati in Durasic®.





# IL SISTEMA DURASIC®

Gli anelli accumulatori della Serie X Plus sono realizzati in Durasic®, straordinario e innovativo materiale composto da carburo di silicio e speciali argille refrattarie con alta resistenza agli shock termici e meccanici. La combinazione dei due elementi esclusivamente di origine naturale, ha dato vita ad un composto dalle eccellenti prestazioni

senza eguali nell'attuale mercato delle stufe ad accumulo. Il risultato è un rapido ed elevato accumulo del calore che verrà rilasciato nell'ambiente in maniera lenta e graduale. Questo rilascio sarà ancora più lungo nel modello X Art rivestito da 97 kg di maiolica e ancora di più nel modello X Rock rivestito con ben 126 kg di pietra naturale.

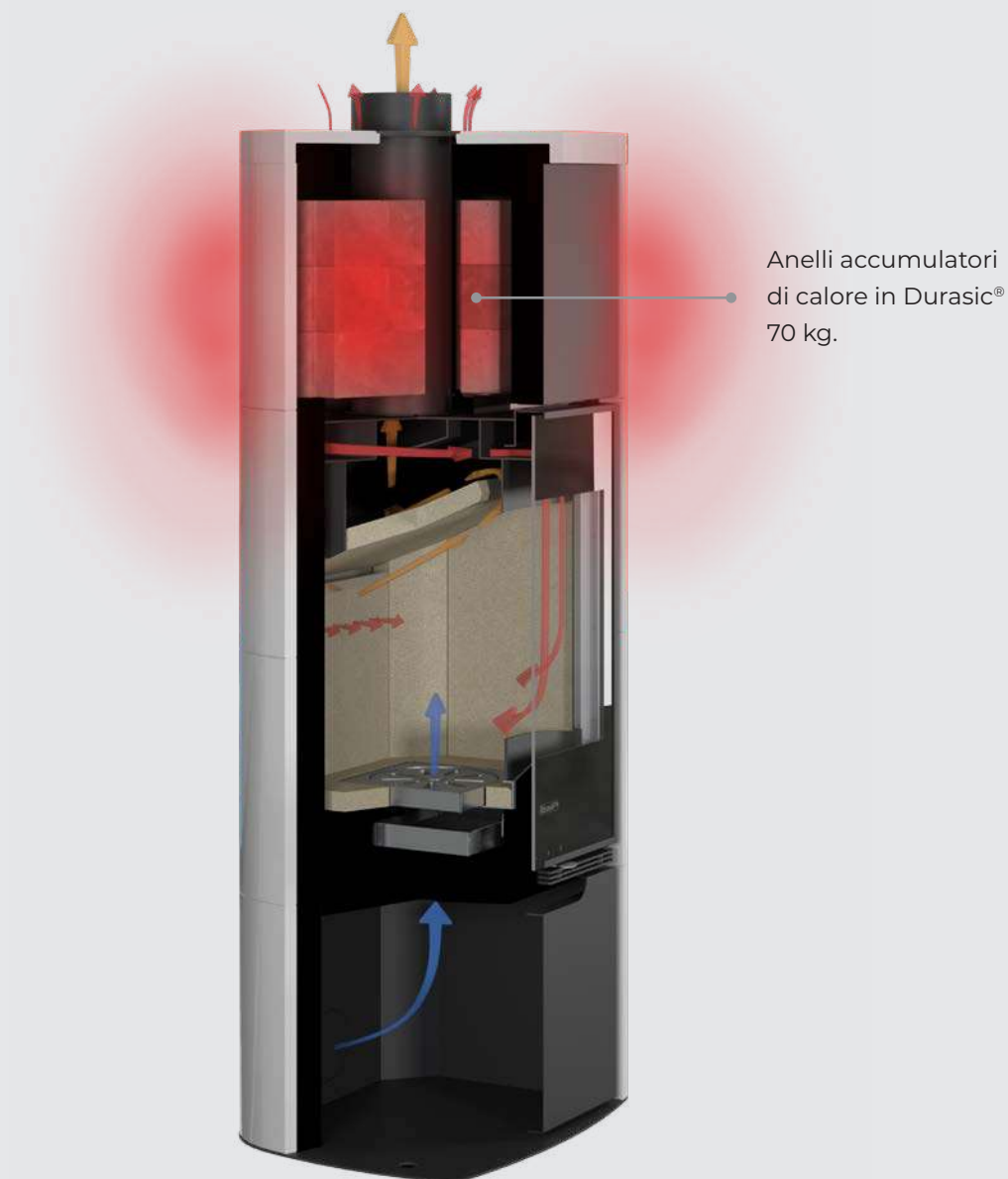

DISTRIBUZIONE DEL CALORE NEL TEMPO CON IL SISTEMA DURASIC®

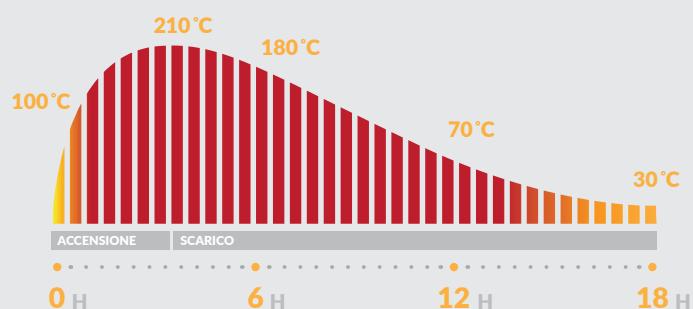





# Serie X Plus



STUFE A LEGNA



## X Line Plus



Misure (LxPxH)  
534x464x1518 mm

    
176/246\* 9,5 13,0

- Acciaio verniciato Nero

- Sportello inferiore (optional)



\* Peso senza e con kit accumulo (70 kg) Durasic® (optional).



## X Rock Plus



Misure (LxPxH)  
554x462x1536 mm

    
302/371\* 9,5 13,0

- Pietra Naturale

- Sportello inferiore (optional)

\* Peso senza e con kit accumulo (70 kg) Durasic® (optional).



# Serie X Plus

STUFE A LEGNA



## X Art Plus



Misure (LxPxH)  
600x476x1546 mm

273/343\* 9,5 13,0

- Maiolica
- Sportello inferiore (optional)

\* Peso senza e con kit accumulo (70 kg) Durasic® (optional).

Valori contributo Conto termico 2.0.  
Riscaldamento a legna. Fonte di grande risparmio.

| Modello | kW     | A        | B        | C        | D         | E         | F         |
|---------|--------|----------|----------|----------|-----------|-----------|-----------|
| X BASIC | 9,5 kW | 543,01 € | 769,27 € | 995,52 € | 1267,03 € | 1538,53 € | 1629,03 € |

Finiture: pag. 38  
Area tecnica: pag. 44

Tecnologie:



# Serie X Chef







## Cucinare con eleganza

La versione Chef della Serie X è dotata di un ampio forno posto immediatamente sopra la camera di combustione della stufa a legna. L'altezza da terra ne fa un comodissimo e pratico strumento di cottura dalle alte prestazioni. Rivestito interamente in acciaio inox, il forno è dotato di teglia, termometro e porta forno con doppio vetro.



# Serie X Chef

STUFE A LEGNA



## X Line Chef



Misure (LxPxH)  
534x464x1518 mm

Misure forno (LxPxH)  
350x320x215 mm

 **KG**  
220

 **kW**  
9,5

 **kW**  
MAX  
13,0

- Acciaio verniciato Nero
- Sportello inferiore (optional)



## X Rock Chef



Misure (LxPxH)  
554x462x1536 mm

Misure forno (LxPxH)  
350x320x215 mm

 **KG**  
340

 **kW**  
9,5

 **kW**  
MAX  
13,0

- Pietra Naturale
- Sportello inferiore (optional)



# Serie X Chef

STUFE A LEGNA



## X Art Chef



Misure (LxPxH)  
600x476x1546 mm

Misure forno (LxPxH)  
350x320x215 mm

280
 9,5
 13,0

- Maiolica
- Sportello inferiore (optional)

### CARATTERISTICHE FORNO

- Forno in acciaio Inox
- Porta forno con doppio vetro
- Porta forno a chiusura magnetica
- Termometro integrato
- Teglia smaltata
- Temperature omogenee oltre i 300°
- Dimensioni del forno: 350x320x215 mm (LxPxH)



Valori contributo Conto termico 2.0.  
Riscaldamento a legna. Fonte di grande risparmio.

| Modello | kW     | A        | B        | C        | D         | E         | F         |
|---------|--------|----------|----------|----------|-----------|-----------|-----------|
| X BASIC | 9,5 kW | 543,01 € | 769,27 € | 995,52 € | 1267,03 € | 1538,53 € | 1629,03 € |

Finiture: pag. 38  
Area tecnica: pag. 44

Tecnologie:



# Serie X Living

## La stufa a legna componibile

Il sistema X Living prevede un corpo stufa principale e una serie di componenti appositamente coordinati e combinabili a piacere intorno alla camera di combustione. In questo modo le possibilità di arredo aumentano considerevolmente in base al gusto e alle esigenze del cliente.





# Serie X Living

STUFE A LEGNA



## X Living



Misure (LxPxH)  
534x464x805 mm

 **KG**  
100

 **kW**  
9,5

 **kW MAX**  
13,0



## Panca

Misure (LxPxH)  
1132x464x340 mm



## Mobile

Misure (LxPxH)  
350x464x1137 mm

Finiture: pag. 38  
Esempi di composizione: pag. 35  
Area tecnica: pag. 44

Tecnologie:





# Crea la tua composizione

Esempio in figura



X living

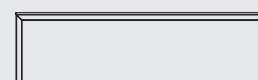

Panca

Esempio in figura



X living

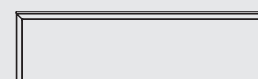

Panca



Mobile

# Serie X Vision

STUFE A LEGNA



X Vision



Misure (LxPxH)  
534x464x1300 mm



170



9,5



13,0

# Serie X Dateo

STUFE A LEGNA



X Dateo



Misure (LxPxH)  
534x464x1170mm



145



9,5



13,0

Finiture: pag. 38  
Area tecnica: pag. 44

Tecnologie:







# Colori e finiture

Tutti i modelli della Serie X sono disponibili in diverse finiture e colori.

## X Line

---



Nero  
(verniciato)

## X Vision

---



Nero  
(verniciato)

## X Dateo

---



Nero  
(verniciato)

## X Living

---



Nero  
(verniciato)

## X Art

---



Bianco  
(rivestimento in maiolica)



Rosso  
(rivestimento in maiolica)



Nero opaco  
(rivestimento in maiolica)

## X Rock

---



Pietra Naturale  
(rivestimento in pietra)





# Inserti a legna



## Fuoco e design

X 50 V è un inserto moderno costruito con materiali solidi e di pregio concepito per riscaldare in modo sano ed ecologico. La maxi camera di combustione con vetro ceramico autopulente darà il meglio di sé in ogni ambiente, creando una bellissima atmosfera grazie ad una fiamma elegante e rilassante.





# Serie X 50 V

INSERTI A LEGNA



X 50 V



Misure (LxPxH)  
520x450x827 mm



100



9,5



13,0

## CARATTERISTICHE PRINCIPALI SERIE X 50 V:

- Corpo ermetico in acciaio
- Graticola cenere rotante in ghisa
- Cassetto cenere estraibile
- Camera di combustione in vermiculite ad alta densità
- Spessore vermiculite 30 mm
- Aria primaria, secondaria e terziaria regolabile
- Uscita fumi superiore e posteriore
- Vetro ceramico da 5 mm con sistema Shiny Glass®
- Maniglie isolate in acciaio verniciato
- Porta fuoco con chiusura automatica di sicurezza
- Presa d'aria esterna - External Air®
- Cornice in acciaio verniciato nero

Area tecnica: pag. 44

Tecnologie:







# Area tecnica

## Specifiche tecniche

| Modelli      | Larghezza | Profondità | Altezza | Bocca di carico (lxh) | Dimensioni del forno (lxpxh) | Peso (Kg.)             | Potenza nominale (kW) | Potenza massima (kW) | Rendimento a potenza nom. % | Flusso gas di scarico (g/s) | Temp. gas di scarico (C°)(2) | Tiraggio consigliato (Pa) |
|--------------|-----------|------------|---------|-----------------------|------------------------------|------------------------|-----------------------|----------------------|-----------------------------|-----------------------------|------------------------------|---------------------------|
| X Art Basic  | 600       | 476        | 1173    | 372x350               | -                            | 240                    | 9,5                   | 13,0                 | 85,2                        | 8,5                         | 195                          | 12                        |
| X Art Plus   | 600       | 476        | 1546    | 372x350               | -                            | 273/343 <sup>(1)</sup> | 9,5                   | 13,0                 | 85,2                        | 8,5                         | 195                          | 12                        |
| X Art Chef   | 600       | 476        | 1546    | 372x350               | 350x320x215                  | 280                    | 9,5                   | 13,0                 | 85,2                        | 8,5                         | 195                          | 12                        |
| X Rock Basic | 550       | 462        | 1163    | 372x350               | -                            | 275                    | 9,5                   | 13,0                 | 85,2                        | 8,5                         | 195                          | 12                        |
| X Rock Plus  | 550       | 462        | 1536    | 372x350               | -                            | 302/371 <sup>(1)</sup> | 9,5                   | 13,0                 | 85,2                        | 8,5                         | 195                          | 12                        |
| X Rock Chef  | 550       | 462        | 1536    | 372x350               | 350x320x215                  | 340                    | 9,5                   | 13,0                 | 85,2                        | 8,5                         | 195                          | 12                        |
| X Line Basic | 534       | 464        | 1145    | 372x350               | -                            | 175                    | 9,5                   | 13,0                 | 85,2                        | 8,5                         | 195                          | 12                        |
| X Line Plus  | 534       | 464        | 1518    | 372x350               | -                            | 176/246 <sup>(1)</sup> | 9,5                   | 13,0                 | 85,2                        | 8,5                         | 195                          | 12                        |
| X Line Chef  | 534       | 464        | 1518    | 372x350               | 350x320x215                  | 220                    | 9,5                   | 13,0                 | 85,2                        | 8,5                         | 195                          | 12                        |
| X Vision     | 534       | 464        | 1300    | 372x350               | -                            | 170                    | 9,5                   | 13,0                 | 85,2                        | 8,5                         | 195                          | 12                        |
| X 50 V       | 520       | 450        | 827     | 372x350               | -                            | 110                    | 9,5                   | 13,0                 | 85,2                        | 8,5                         | 195                          | 12                        |
| X Dateo      | 534       | 464        | 1170    | 372x350               | -                            | 145                    | 9,5                   | 13,0                 | 85,2                        | 8,5                         | 195                          | 12                        |
| X Living     | 534       | 464        | 805     | 372x350               | -                            | 120                    | 9,5                   | 13,0                 | 85,2                        | 8,5                         | 195                          | 12                        |

Misure in mm

(1) Peso senza e con kit accumulo (70 kg) Durasic® (optional).

(2) Temperatura media alla potenza nominale. Si possono avere temperature dei fumi istantanee superiori. Si raccomanda di utilizzare sempre tubazioni con specifica minima T400.



## Dotazioni

### Modelli

|              | Presa d'aria esterna - External Air® | Reg. aria primaria, secondaria, terziaria | Sistema di combustione - Superflame® | Porta fuoco con vetro ceramico - Shiny Glass® | Porta fuoco con chiusura autom. di sicurezza | Forno in acciaio inox | Porta forno con doppio vetro e termometro | Piedini livellatori regolabili | Vano porta legna aperto | Sportello vano porta legna | Uscita fumi superiore | Uscita fumi posteriore | Lamiera copripavimento | Sistema ad accumulo Durasic® |
|--------------|--------------------------------------|---|--------------------------------------|---|--|-----------------------|---|--------------------------------|-------------------------|----------------------------|-----------------------|------------------------|------------------------|------------------------------|
| X Art Basic  | ☺                                    | ☺   | ☺                                    | ☺   | ☺  | -                     | -   | ☺                              | ☺                       | ☺                          | ☺                     | ☺                      | ☺                      | -                            |
| X Art Plus   | ☺                                    | ☺   | ☺                                    | ☺   | ☺  | -                     | -   | ☺                              | ☺                       | ☺                          | ☺                     | -                      | ☺                      | ☺                            |
| X Art Chef   | ☺                                    | ☺   | ☺                                    | ☺   | ☺  | ☺                     | ☺   | ☺                              | ☺                       | ☺                          | ☺                     | -                      | ☺                      | -                            |
| X Rock Basic | ☺                                    | ☺   | ☺                                    | ☺   | ☺  | -                     | -   | ☺                              | ☺                       | ☺                          | ☺                     | ☺                      | ☺                      | -                            |
| X Rock Plus  | ☺                                    | ☺   | ☺                                    | ☺   | ☺  | -                     | -   | ☺                              | ☺                       | ☺                          | ☺                     | -                      | ☺                      | ☺                            |
| X Rock Chef  | ☺                                    | ☺   | ☺                                    | ☺   | ☺  | ☺                     | ☺   | ☺                              | ☺                       | ☺                          | ☺                     | -                      | ☺                      | -                            |
| X Line Basic | ☺                                    | ☺   | ☺                                    | ☺   | ☺  | -                     | -   | ☺                              | ☺                       | ☺                          | ☺                     | ☺                      | ☺                      | -                            |
| X Line Plus  | ☺                                    | ☺   | ☺                                    | ☺   | ☺  | -                     | -   | ☺                              | ☺                       | ☺                          | ☺                     | -                      | ☺                      | ☺                            |
| X Line Chef  | ☺                                    | ☺   | ☺                                    | ☺   | ☺  | ☺                     | ☺   | ☺                              | ☺                       | ☺                          | ☺                     | -                      | ☺                      | -                            |
| X Vision     | ☺                                    | ☺   | ☺                                    | ☺   | ☺  | -                     | -   | -                              | -                       | -                          | ☺                     | ☺                      | ☺                      | -                            |
| X 50 V       | ☺                                    | ☺   | ☺                                    | ☺   | ☺  | -                     | -   | -                              | -                       | -                          | ☺                     | ☺                      | ☺                      | -                            |
| X Dateo      | ☺                                    | ☺   | ☺                                    | ☺   | ☺  | -                     | -   | -                              | -                       | -                          | ☺                     | ☺                      | ☺                      | -                            |
| X Living     | ☺                                    | ☺   | ☺                                    | ☺   | ☺  | -                     | -   | -                              | -                       | -                          | ☺                     | ☺                      | ☺                      | -                            |

☺ di serie ☺ optional - non disponibile

## Uscita fumi Serie X

| Modelli      | A    | B   | C   | D   | ø   |
|--------------|------|-----|-----|-----|-----|
| X Art Basic  | 1020 | 300 | 185 | 300 | 150 |
| X Art Plus   | -    | -   | 185 | 300 | 150 |
| X Art Chef   | -    | -   | 185 | 300 | 150 |
| X Rock Basic | 1020 | 277 | 195 | 277 | 150 |
| X Rock Plus  | -    | -   | 195 | 277 | 150 |
| X Rock Chef  | -    | -   | 195 | 277 | 150 |
| X Line Basic | 1020 | 267 | 195 | 267 | 150 |
| X Line Plus  | -    | -   | 195 | 267 | 150 |
| X Line Chef  | -    | -   | 195 | 267 | 150 |
| X Vision     | 1180 | 267 | 195 | 267 | 150 |
| X 50 V       | 689  | 260 | 260 | 270 | 150 |
| X Dateo      | 1018 | 267 | 267 | 270 | 150 |
| X Living     | 677  | 267 | 267 | 270 | 150 |

Misure in mm

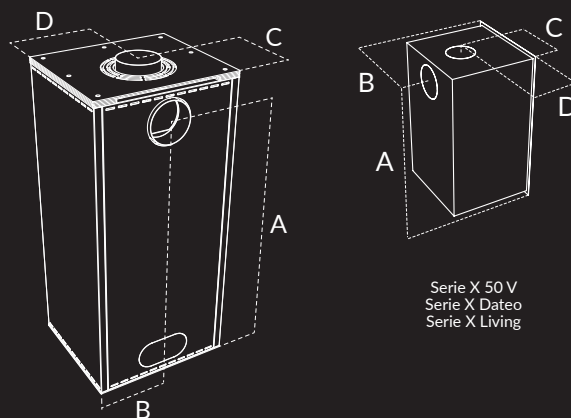

Serie X

Serie X 50 V  
Serie X Dateo  
Serie X Living

## Preso d'aria esterna Serie X

| Modelli      | A  | B   | C   | D   | F   | H   | ø  |
|--------------|----|-----|-----|-----|-----|-----|----|
| X Art Basic  | 95 | 210 | 110 | 300 | 111 | 388 | 75 |
| X Art Plus   | 95 | 210 | 110 | 300 | 111 | 388 | 75 |
| X Art Chef   | 95 | 210 | 110 | 300 | 111 | 388 | 75 |
| X Rock Basic | 95 | 210 | 110 | 275 | 120 | 388 | 75 |
| X Rock Plus  | 95 | 210 | 110 | 275 | 120 | 388 | 75 |
| X Rock Chef  | 95 | 210 | 110 | 275 | 120 | 388 | 75 |
| X Line Basic | 95 | 210 | 110 | 267 | 120 | 388 | 75 |
| X Line Plus  | 95 | 210 | 110 | 267 | 120 | 388 | 75 |
| X Line Chef  | 95 | 210 | 110 | 267 | 120 | 388 | 75 |
| X Vision     | 95 | 110 | 110 | 267 | 83  | 543 | 75 |
| X 50 V       | 84 | -   | 210 | 260 | 69  | 56  | 75 |
| X Dateo      | -  | -   | -   | 267 | 83  | 383 | 75 |
| X Living     | -  | -   | -   | 267 | 83  | 44  | 75 |

Misure in mm

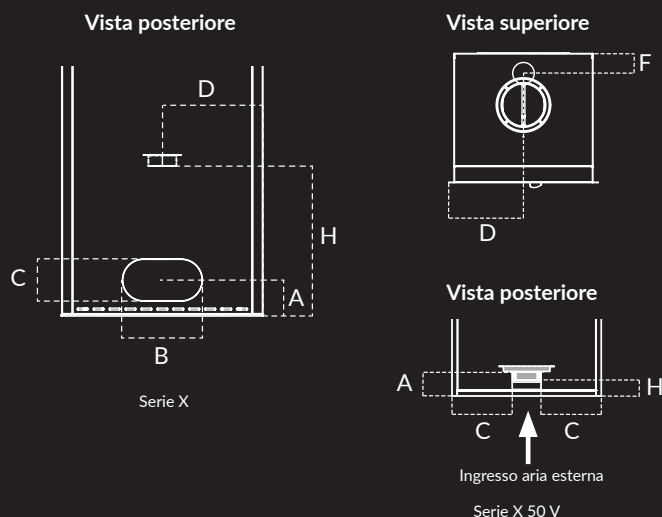

Vista superiore

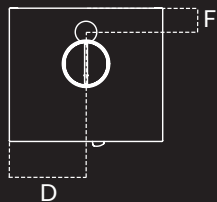

Vista posteriore

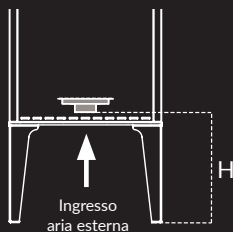

Serie X Dateo

Vista superiore

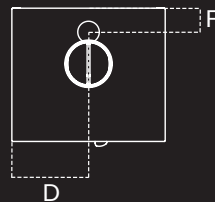

Vista posteriore

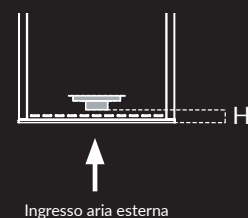

Serie X Living







# RIZZOLI®

**Rizzoli s.r.l. - Unica sede**  
Zona Artigianale 1, Frazione San Lugano  
39040 Trodena nel Parco Naturale (BZ) - Italia  
Tel. +39 0471 887551  
info@rizzolicucine.it - www.rizzolicucine.it



#rizzolicucine